

Installation Horizontals

HORIZONTAL BLINDS

INSTALLATION INSTRUCTIONS

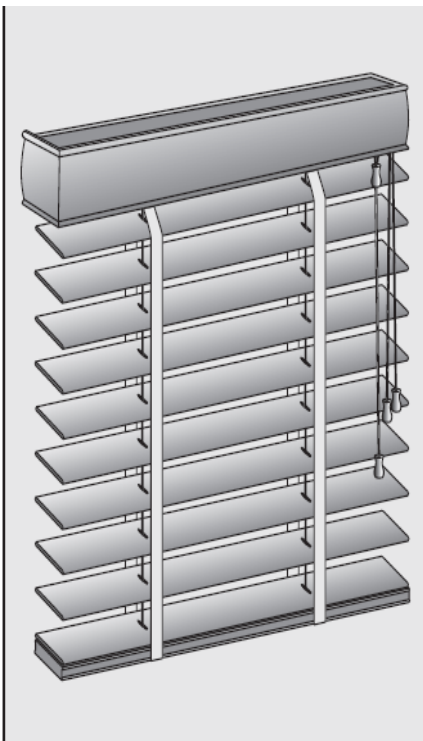

**Read all
installation instructions
before installation.**

CHILD SAFETY

An important consideration in any blind installation is child safety. To prevent serious injuries or strangulations, all cords must be kept out of the reach of children. Cord stops and cord cleats are an effective way to implement this essential precaution.

SAFETY CORD STOPS

To reduce the chance of children forming a hazardous loop by pulling out the inner cords (lift cords) of horizontal blinds, all horizontal blinds include safety cord stops. The cord stops are knotted to each lift cord 1" to 2" below the headrail cordlock to prevent the lift cords from travelling backwards through the cord lock. Some blinds may come with a decorative tassel placed where you see the safety cord stops. This serves the same purpose.

SAFETY CORD CLEATS

Cord cleats are included with every horizontal blind. Mount the cord at a safe height, taking into account furniture or other objects upon which a child may climb. Then, after each use of the blind, simply wrap the excess cord around the cleat.



CARE AND CLEANING

DUSTING

Keep your horizontal blinds looking their best by dusting regularly. Wipe them with a soft, clean, cloth, dusting mitt or round brush attachment from a vacuum cleaner. You may dust or clean in place by tilting slats down, but not quite closed - you will be able to reach most of the surface of each slat. You may also wipe slats with a soft, damp cloth. Do not use a damp cloth on stained real wood or glossy because water may affect their finish or sheen. For painted wood and faux wood blinds use a damp, soft, cloth. Like fine furniture - stained real wood blinds should be periodically treated w/ lemon oil to protect finish & enhance luster. For aluminum blinds, please use a soft, clean, cloth. Ultra Sonic cleaning of ANY horizontal blind not recommended.

Hold Down Brackets

Hold-downs are optional and must be requested at time of order. This is usually requested when mounting shades to a door. The hold down fits into a pre-drilled hole in bottom rail to secure bottom rail in place.

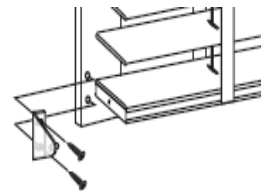

Mounting Brackets

The box style mounting brackets are designed to work in all possible mounting applications. The diagram below indicates which screw holes to use for each option.

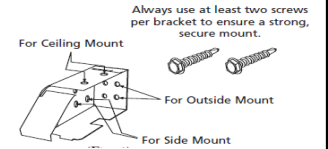

Mount brackets as shown below. Always use all brackets supplied. Blinds over 48" wide must have one center support bracket, blinds over 72" wide must have 2. Space the support/middle brackets as evenly as possible between the two end brackets. There should be no more than 48" between any two brackets. Avoid positioning support/middle brackets in line with blind ladders or tapes. Blinds over 114" in height and multiple blinds on one headrail over 96" wide require an additional support bracket positioned 7" from the cordlock of the headrail. Use 2 screws to attach each support bracket. Locate the screws diagonally. Make sure the support bracket's top and back surfaces are aligned with the top and back surfaces of the two installation brackets.

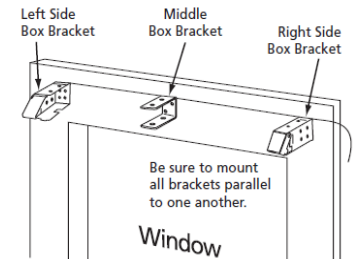

Installation Horizontals

Outside Mount

First mark where to attach the 2 installation brackets.

Hold the blind up to the window in the position where you want it installed. With the blind centered and level mark the surface 1/4" past each end of the headrail.

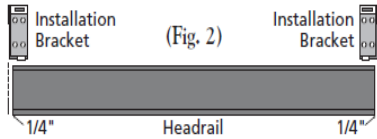

Attach the installation brackets to the wall or molding with 2 screws. Position the screws diagonally as shown below. Note, that the spacers are used with 2-1/2" blinds only.

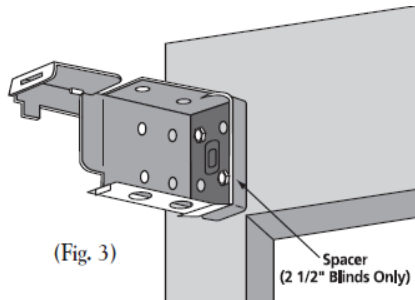

Brackets Required

All Horizontal blinds require 2 end brackets.

All 2 on 1 headrail blinds receive 1 center supports

All 3 on 1 headrail blinds receive 3 center supports

Center support brackets for 2 on 1 and 3 on 1 should be placed between panels

Position the headrail in the box brackets as shown below. Swing the covers down and snap closed.

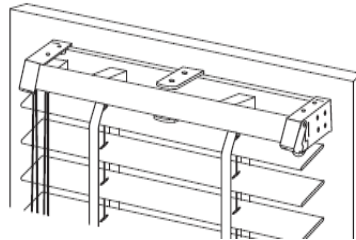

2- 1/2" Blind Installation Note

Spacer Blocks

The slat on a 2-1/2" blind extends beyond the back of the headrail.

Spacer blocks must be used for all outside mount applications. Use 2 spacer blocks for each installation bracket.

For inside mount applications, there must be a minimum of 1/4" between back of headrail and any obstruction.

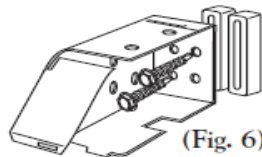

Privacy Slat- Routless Option

Notes:

Due to the unique stringing method of routless or privacy option blinds- slats may become disengaged during shipping, installation, or aggressive use. To ensure proper installation of the privacy/routless blind, it is important to check the engagement of the slats on the ladderbraided. The notch on the edge of the slat should align with the ladder braid as shown below. Slat A is properly engaged while slat B has disengaged. To fix a disengaged slat, simply move the slat by hand until the notch is properly seated on the ladderbraided.

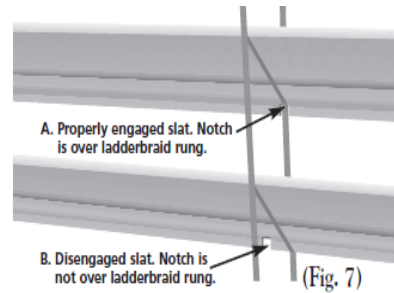

Routless/Privacy Blind Operation

For optimal performance, Routless or Privacy option blinds, should only be raised and lowered when the slats are in the open position.

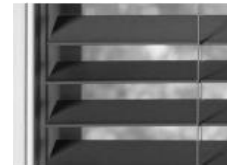

Valance Attachment

Your blinds will be shipped with either valance clips or with magnets.

If Using Valance Clips: See Photo Below

Install one clip on each end and space any others evenly in between, no more than 48" apart.

Important: Install valance clips BEFORE mounting the headrail. Then after mounting the headrail, attach the valance. Simply snap the valance into the clips.

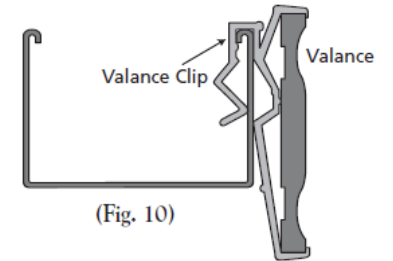

If Installing A Valance With Magnets

Install Blind into brackets and simply attach the valance onto steel headrail. Magnets will grab the headrail snugly but still allows you to position it easily.



Important Note:

If the valance has returns they will come attached as shown with magnets.